

ATLAS 60

BENCHMOUNT | WALLMOUNT

AIR-COOLED

OZONE GENERATORS

ATLAS 60

AIR-COOLED OZONE GENERATOR

LET'S PUT OZONE TO WORK FOR YOU

**EFFECTIVELY RELIABLY AND
ECONOMICALLY**



Best Performance

Unparalleled for Air-cooled

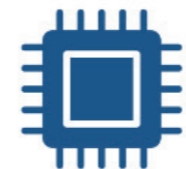

High-Quality Components

5-year Warranty



Compact Design

Easy to integrate



Smart

Diagnostic & Control systems

TECHNICAL SPECIFICATION

EXPERIENCE UNBEATABLE AND GUARANTEED PERFORMANCE

Model:	ATLAS 60	ATLAS 60 LP (Low Pressure)
Ozone Production:	60 (g/h)	60 (g/h)
Optimal Pressure:	25-40 SPSI	20 PSIG
Concentration:	up to 14% w/w	up to 14% w/w

Absolute Ozone offered the standard ATLAS 60 that operates at 25-40PSIG operating pressure and the ATLAS 60 LP (Low Pressure) version that operates at 20 PSIG.

The ATLAS 60 would require industrial oxygen generator system, while the ATLAS 60 LP would be working off with two self-contained oxygen generators working in parallel.

ATLAS 60

HIGH-PRESSURE WITH INDUSTRIAL OXYGEN SYSTEMS



Oil-Less Rotary Scroll Compressor
with installed disiccant dryer

Oxygen Concentrator

Absolute Ozone®
ATLAS 60

Flow meter

Immerse yourself in the forefront of disinfection with our High-Pressure version. This ozone generator re-defines the standard, requiring a robust industrial oxygen generation system to unleash its full potential.

ATLAS 60 LP

LOW PRESSURE WITH TWO OXYGEN GENERATORS

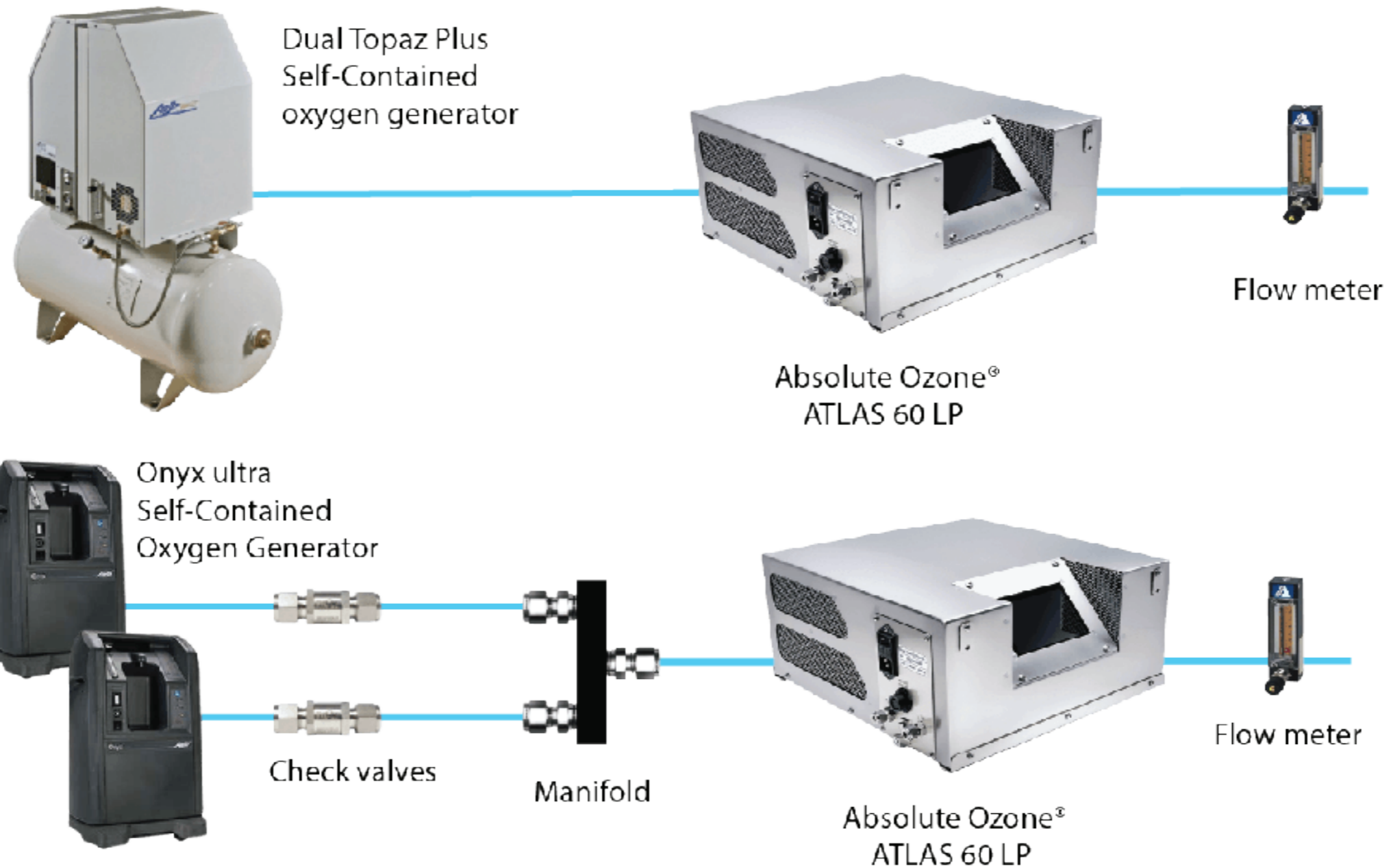

Discover the smart simplicity of our Low-Pressure version. This ozone generator offers an affordable and efficient alternative, harnessing the combination of two low-cost oxygen generators.

SMARTEST OZONE GENERATOR IN THE WORLD

ADVANCED ON-BOARD PROTECTION & CONTROL SYSTEM

Introducing iOzone™, the cutting-edge operating system from Absolute Ozone®. Featuring a 5-inch LCD, this innovative system boasts state-of-the-art diagnostic and control systems to ensure uninterrupted 24/7 ozone production and minimize downtime.



iOzone™ diagnostics/control system

Designed to protect against installation or usage issues like incorrect gas pressure, high ambient temperatures, flooded ozone cells, wiring/voltage problems and more.



LCD screen

The LCD screen will allow touch to switch the generator on and off and to adjust the desired power.



Remote control

The instrument comes with 4-20mA Remote Control Inputs, allowing for precise device control via external signals.



DESIGN

COMPACT AND EFFICIENT OZONE GENERATORS

- **Most compact in the Industry:**

ATLAS 60 - Absolute Ozone® Generators have dimensions of 14" x 15" x 7" Only! – saves valuable space and money on shipping.

- **Stacking Component:**

Absolute Ozone® generators have a stacking component for multiple units, allowing for desired ozone concentration and future expansion up to 5 kg/h or more.

- **Reversible Universal Mounting Flange:**

Our ozone generator has reversible mounting flanges, making it flexible for horizontal and vertical setups, optimizing accessibility in any industrial environment.

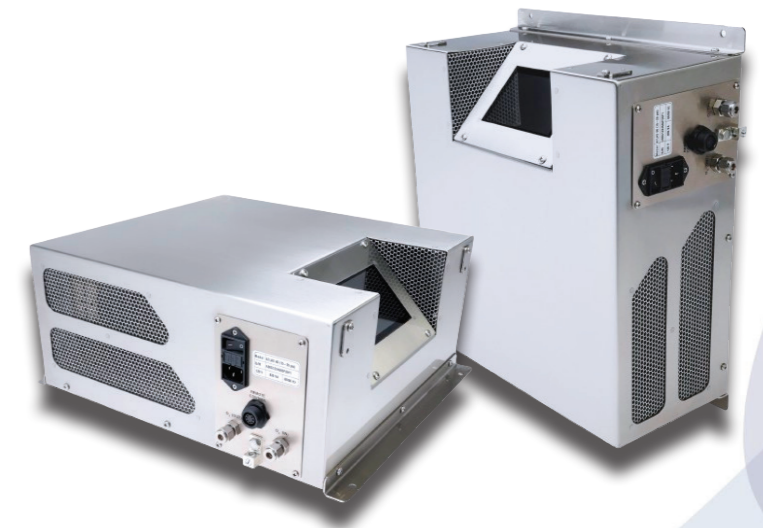
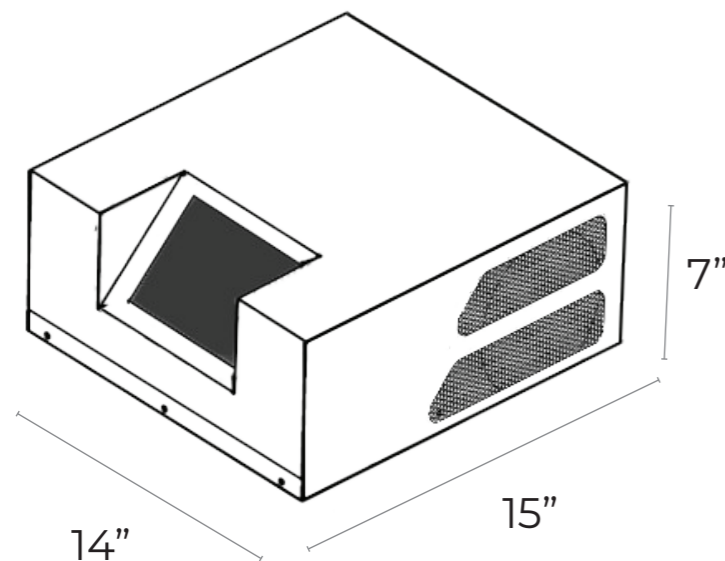

HIGH-PERFORMANCE OZONE GENERATORS

ABSOLUTE OZONE® GENERATORS WILL SAVE YOUR MONEY

- **5-Year Warranty**

Peace of mind with our 5-year warranty, plus a performance guarantee. Our reliable Absolute Ozone® generators save you money on repairs and downtime.

- **Technical Support**

Our technical assistance to our customers is complimentary, unlimited and absolutely free of charge.

- **Crafted for reliability and performance**

Exceptional reliability. Leak-proof design tested up to 150 PSIG, corrosion-resistant stainless steel enclosure, highest quality components.

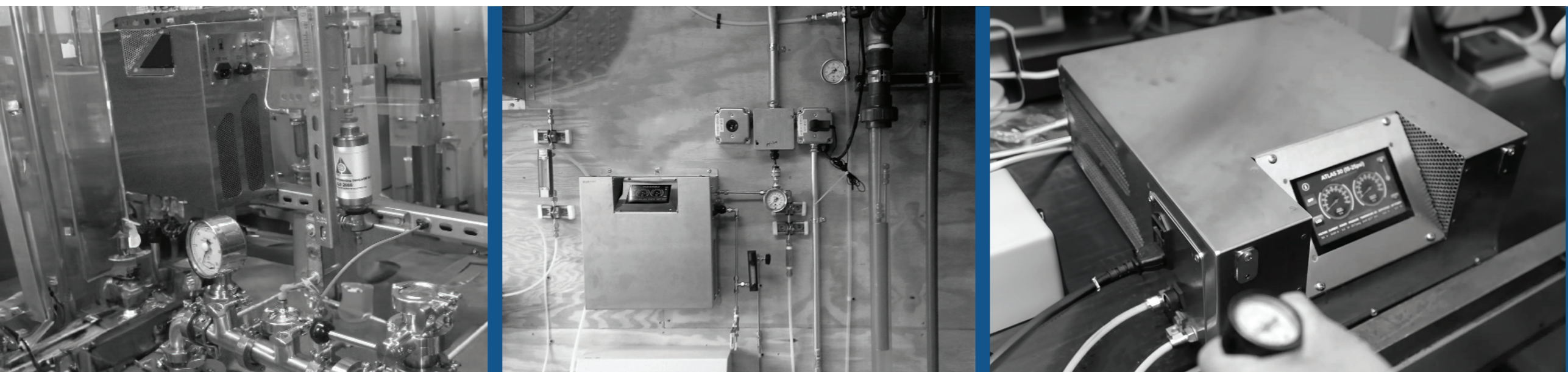

SPECIFICATIONS

Ozone (O ₃) Production:	60 g/h
Working Pressure:	20 PSIG or 25-45 PSIG
Concentration:	12% by weight Guaranteed
Feed Gas (O ₂) Flow Rate:	0.1-14 SLPM
Dimensions:	14 x 15 x 7 inches (WxDxH)
Weight:	35 lbs.
Control Power Requirements:	120 V ~ +/-10%, 50/60 Hz, Single Phase, 5.6 A 220 V ~ +/-10%, 50/60 Hz, Single Phase, 3.0 A
Maximum Power Consumption:	700W
Remote Control:	4-20mA Remote Control Inputs
Physical Connections:	O ₂ Inlet: 0.25" SS316 Comp. Connector O ₃ Outlet: 0.25" SS316 Comp. Connector



*Typical Installation of the Absolute Ozone® ATLAS 60 LP

APPLICATIONS

DISCOVER THE BEST SOLUTION FOR YOUR APPLICATION

Today, Ozone is being implemented in a continually expanding array of applications.

At Absolute Ozone®, we are focusing our efforts on the applications and markets in which we can make significant impacts.

- Wastewater Treatment
- Drinking Water Treatment
- Water Parks, Swimming Pools, Spas
- Air & Soil Remediation
- Aquaculture, Zoos & Hatcheries
- Food Processing & Storage
- Laboratory
- Semiconductor
- Laundry Applications
- Agriculture
- Cosmetics
- Livestock and Poultry
- Medical
- Ozone Therapy

...and many more.

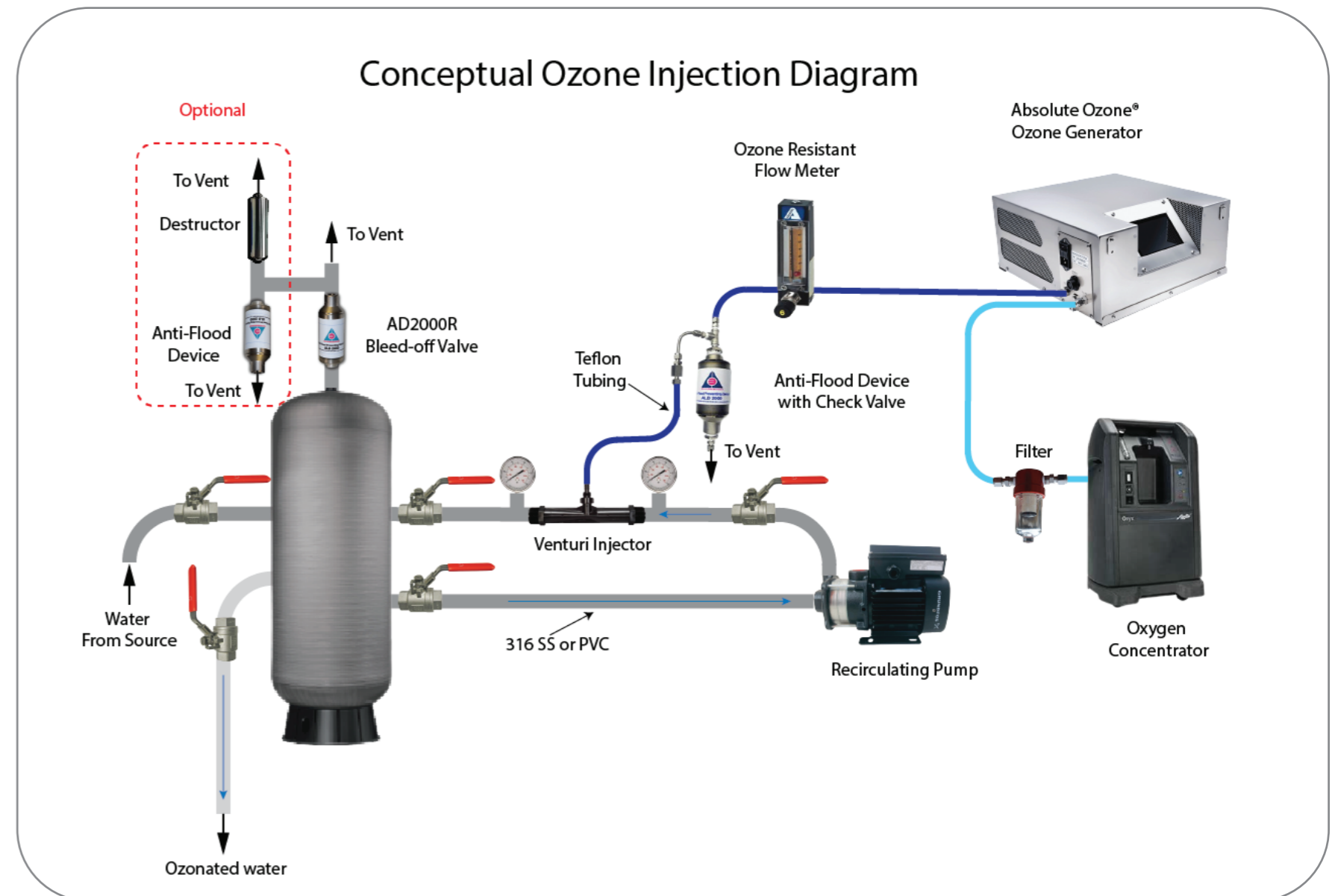

OUR CUSTOMERS

JUST A FEW OF THE MAJOR BRANDS & COMPANIES THAT RELY ON ABSOLUTE OZONE GENERATORS

For the past three decades, we have consistently delivered reliable and highly efficient ozone generators to our valued clients. These systems have not only proven instrumental in their operations but have also led to substantial cost savings.

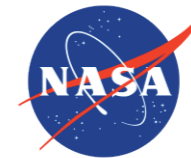

Absolute Ozone®, a leader in ozone generation technology since 1985, supplies top-tier ozone generators to 100+ countries worldwide.

Over three decades, we have focused on ensuring client project success through reliable, economical, and effective ozone generators.

We offer a unique opportunity to our customers by providing the most advanced Absolute Ozone generators, guaranteeing equipment effectiveness, project success, and substantial cost savings.

Our unlimited, complimentary technical assistance is a cornerstone of our commitment to customer support.



Get In Touch



Message Us

office@absoluteozone.com



Address

10712 -181 Street, Edmonton, AB
Canada, T5S1K8



Customer Service

+1 780-486-3200

For more information, please visit our website, Or please feel free to give us a call